

Geisli 2

Eyðublöð



NÁMSGAGNASTOFNUN

STÆRÐFRÆÐ

STÆRÐFRÆÐI

Pinnabretti

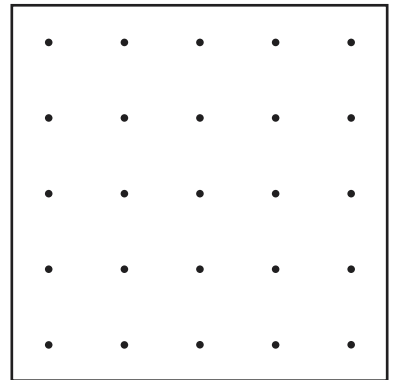
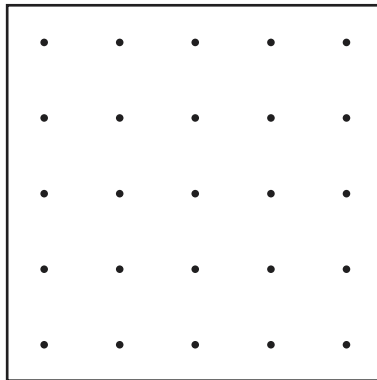
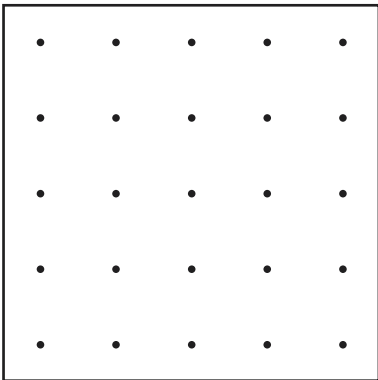
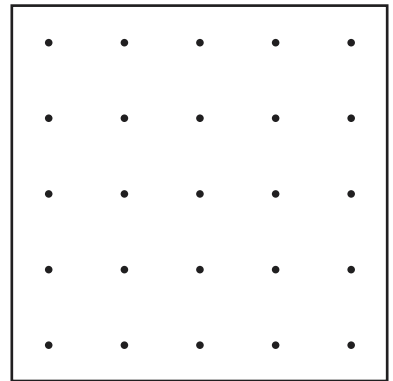
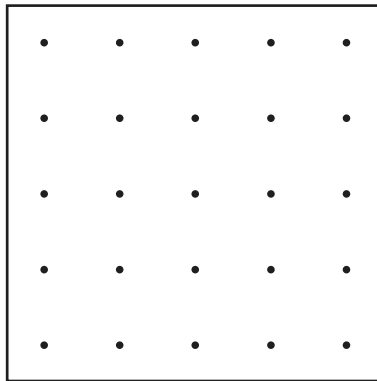
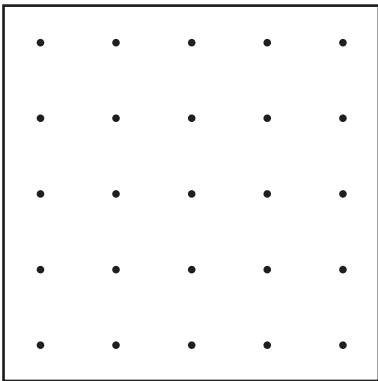
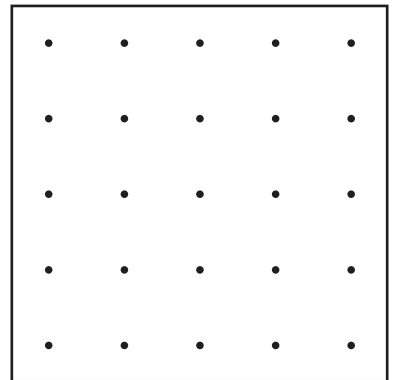
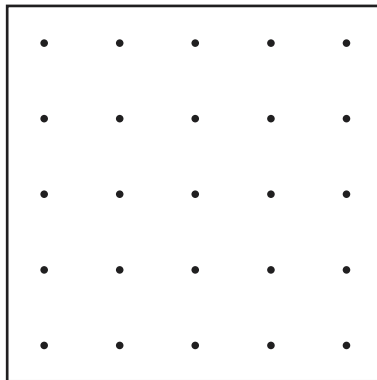
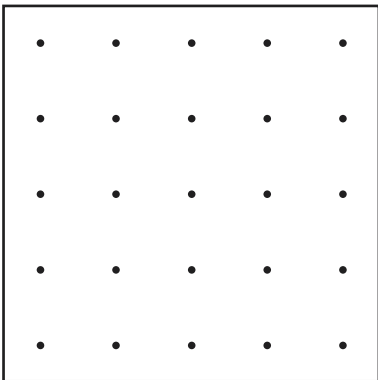
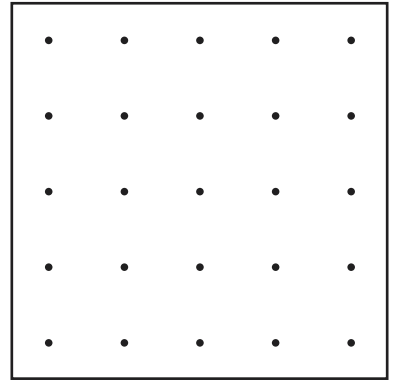
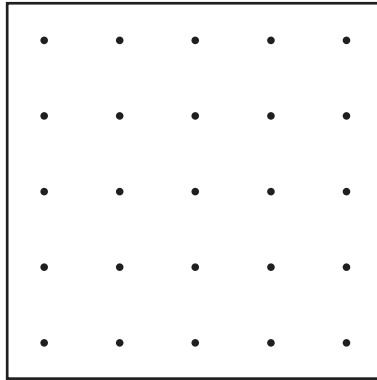
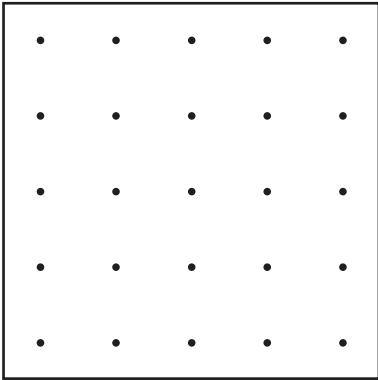

STÆRÐFRÆÐI

Punktablað – tíglar 1

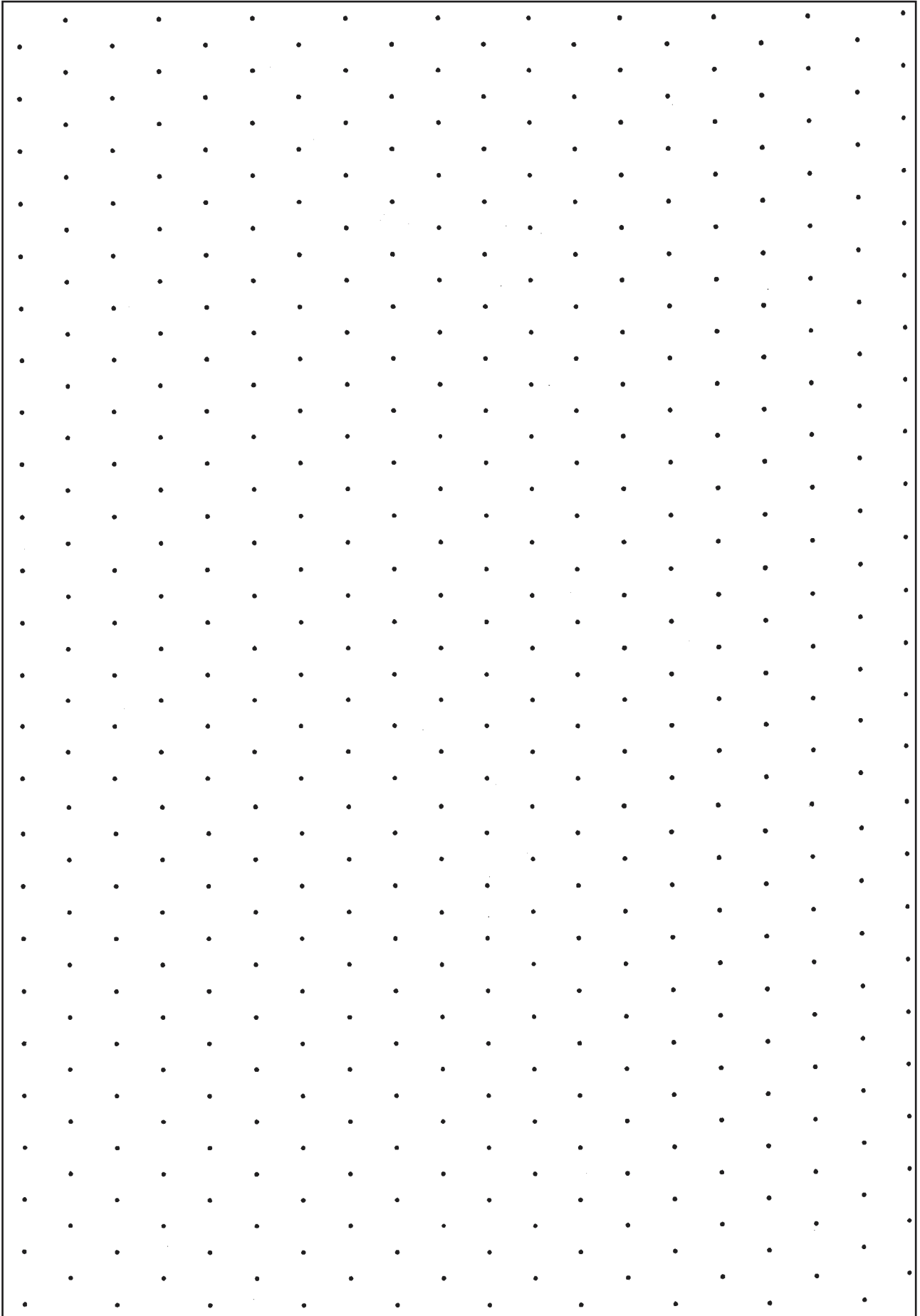

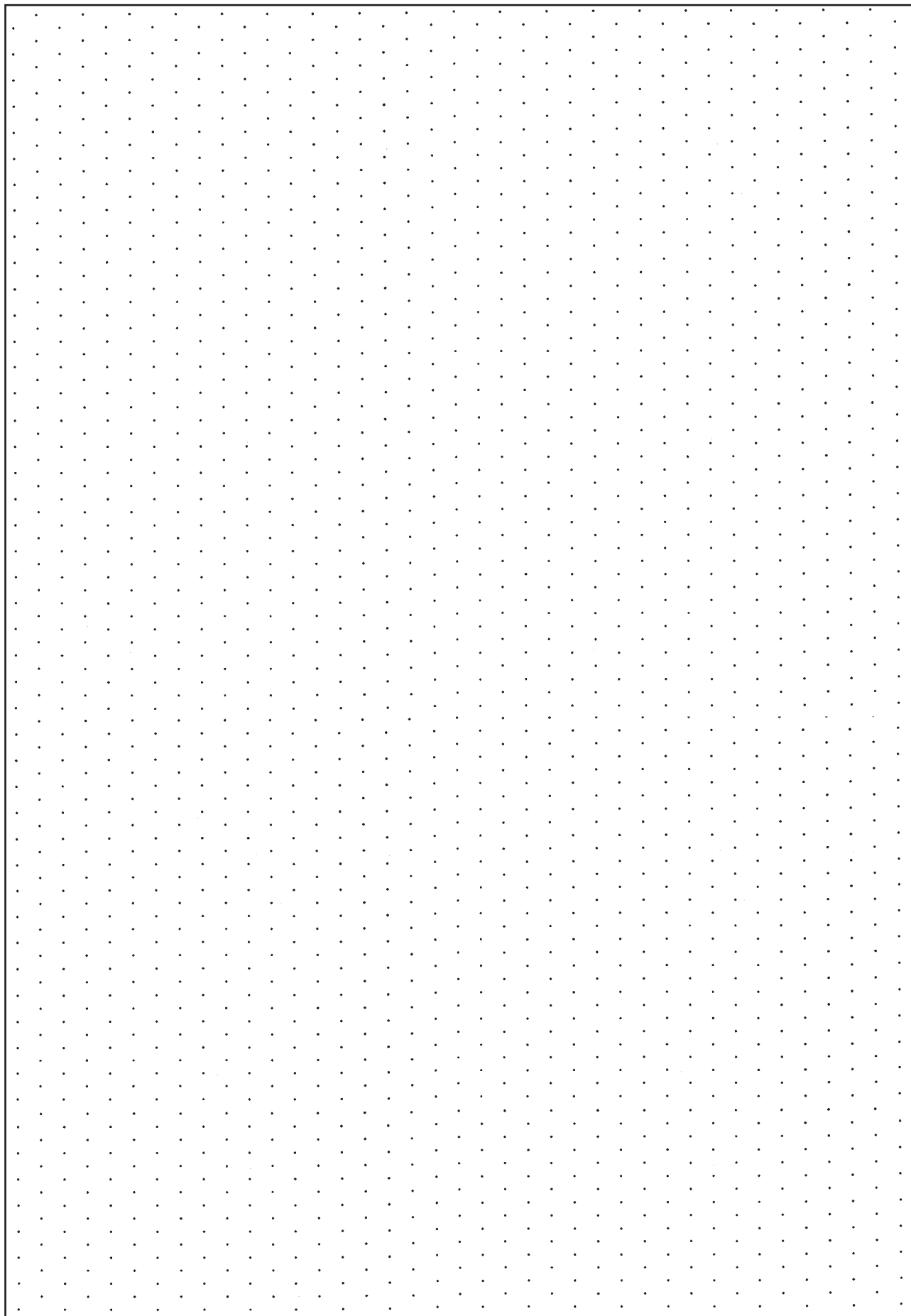

STÆRÐFRÆÐI

Punktablað – ferningar 1

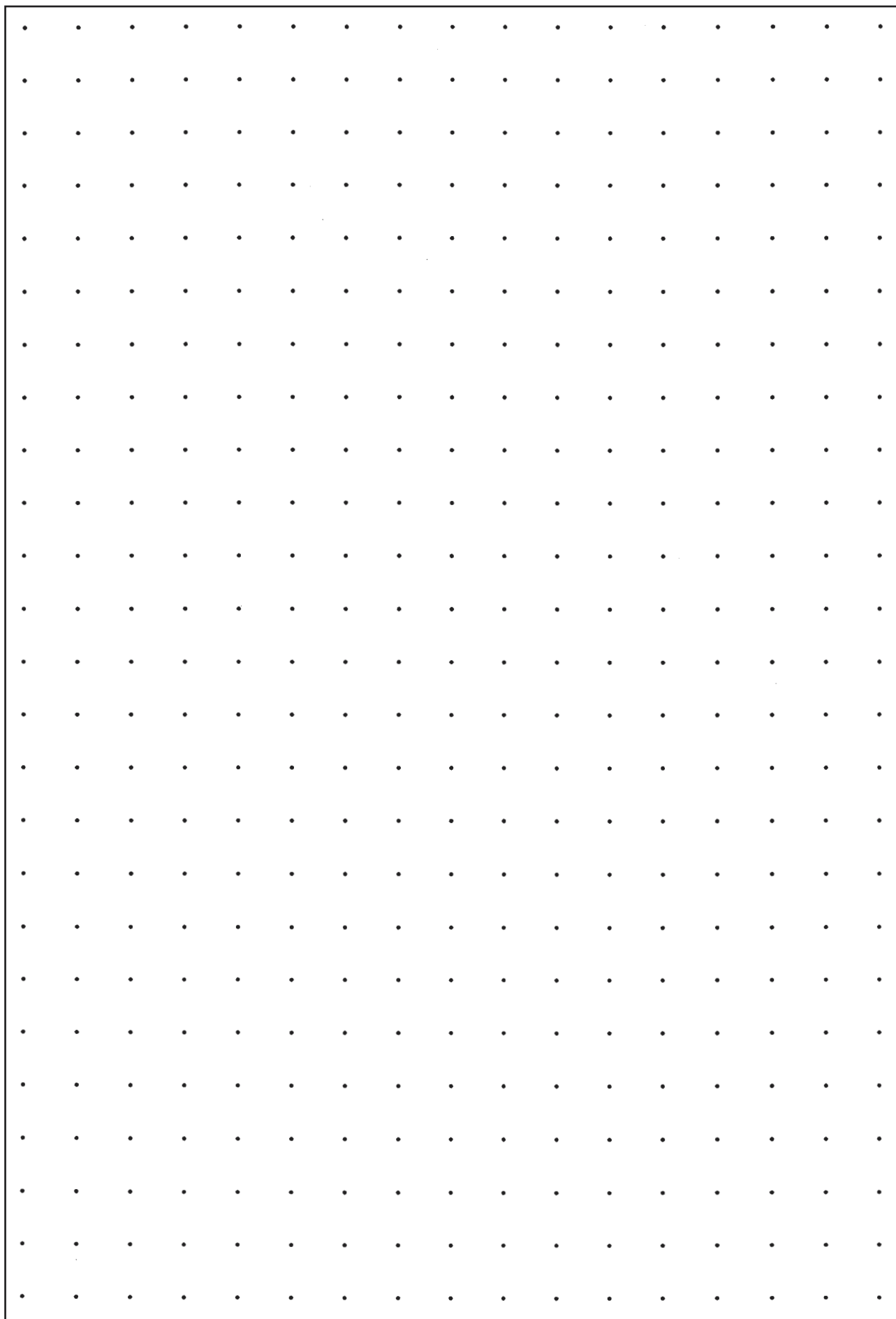

STÆRÐFRÆÐI

Punktablað – ferningar 2

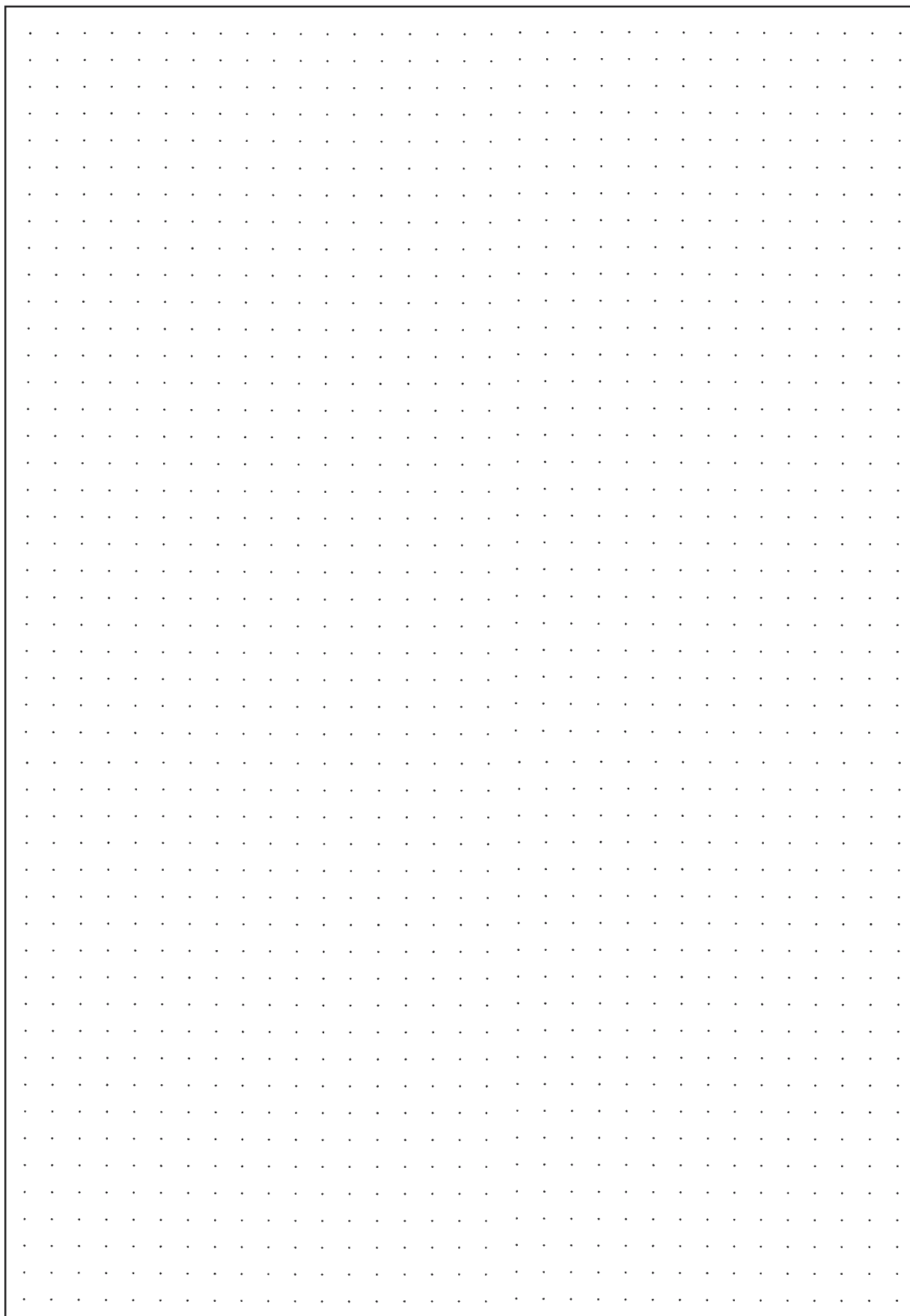

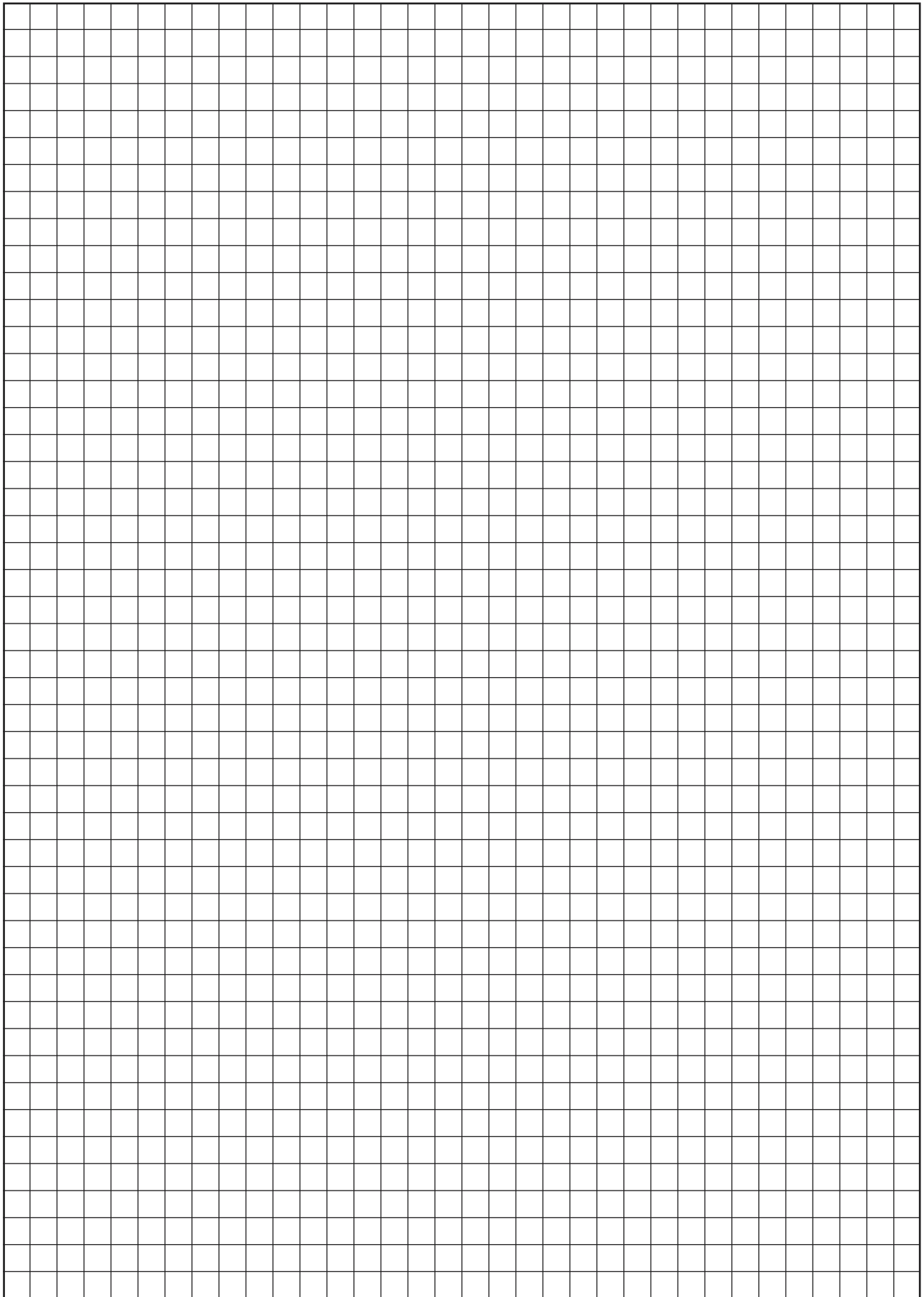

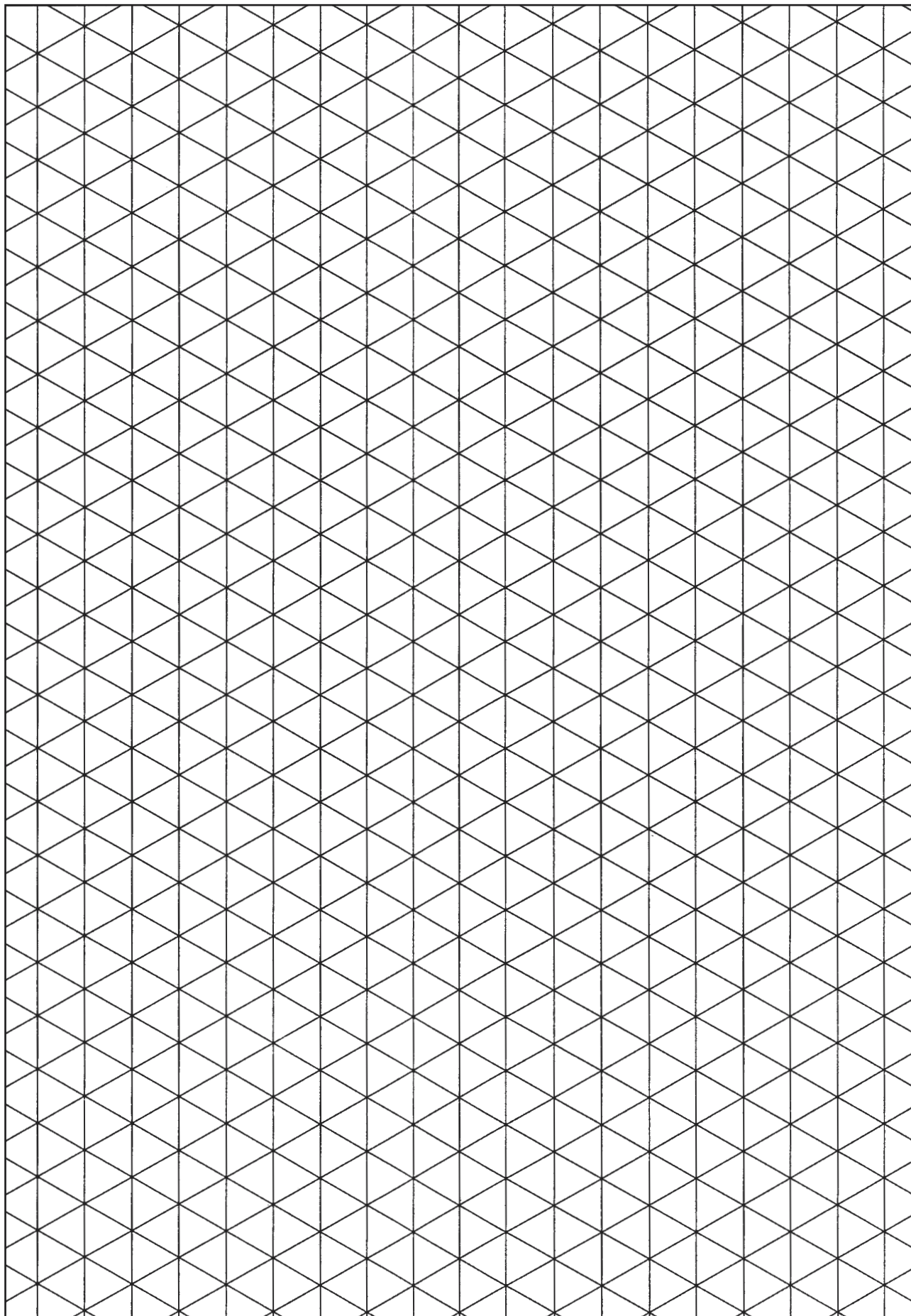

STÆRÐFRÆÐI

Mynstur 2 – þríhyrningar

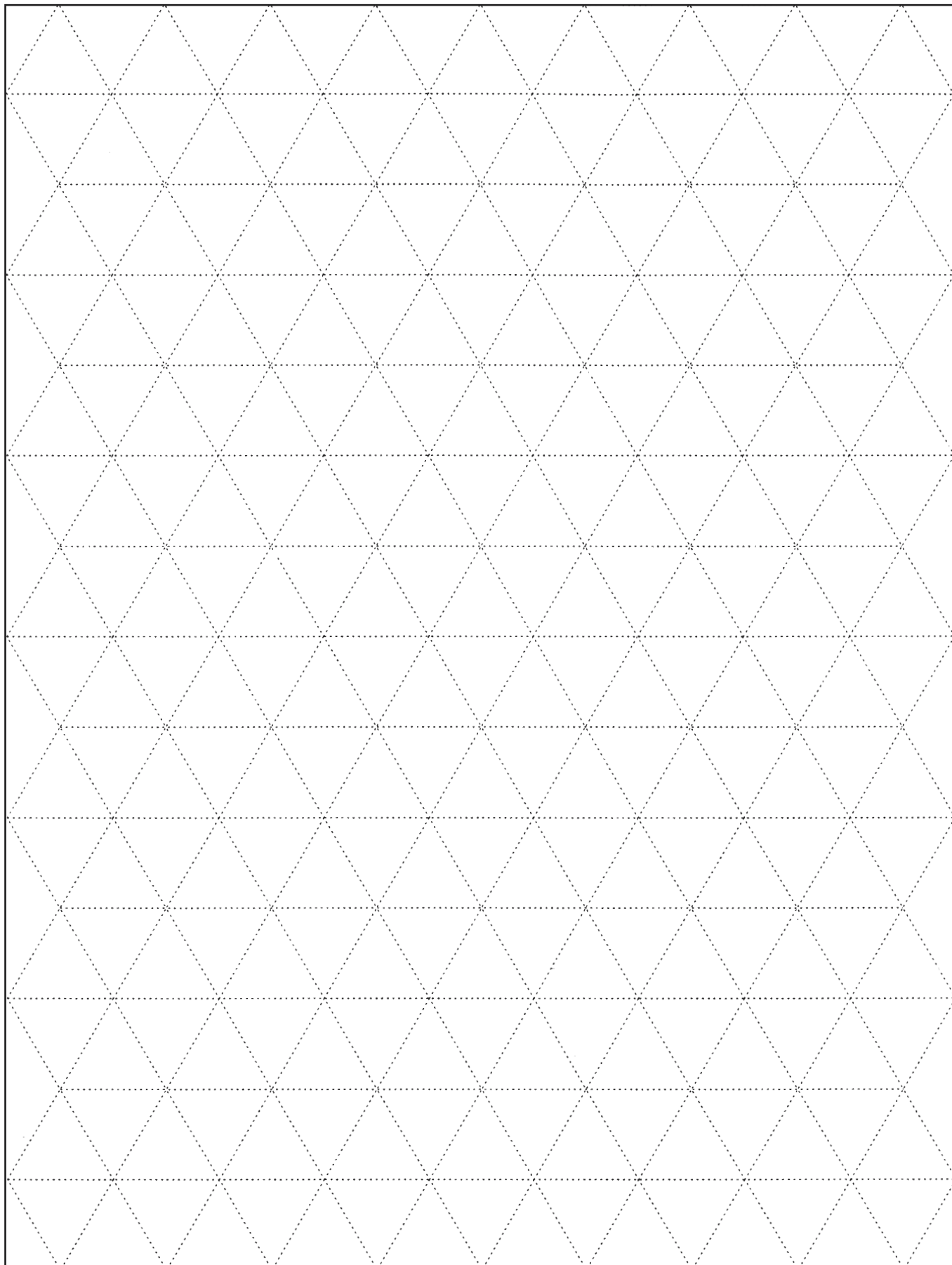

Hundrað talna tafla

1	2	3	4	5	6	7	8	9	10
11	12	13	14	15	16	17	18	19	20
21	22	23	24	25	26	27	28	29	30
31	32	33	34	35	36	37	38	39	40
41	42	43	44	45	46	47	48	49	50
51	52	53	54	55	56	57	58	59	60
61	62	63	64	65	66	67	68	69	70
71	72	73	74	75	76	77	78	79	80
81	82	83	84	85	86	87	88	89	90
91	92	93	94	95	96	97	98	99	100



Hundrað talna töflur

1	2	3	4	5	6	7	8	9	10
11	12	13	14	15	16	17	18	19	20
21	22	23	24	25	26	27	28	29	30
31	32	33	34	35	36	37	38	39	40
41	42	43	44	45	46	47	48	49	50
51	52	53	54	55	56	57	58	59	60
61	62	63	64	65	66	67	68	69	70
71	72	73	74	75	76	77	78	79	80
81	82	83	84	85	86	87	88	89	90
91	92	93	94	95	96	97	98	99	100

1	2	3	4	5	6	7	8	9	10
11	12	13	14	15	16	17	18	19	20
21	22	23	24	25	26	27	28	29	30
31	32	33	34	35	36	37	38	39	40
41	42	43	44	45	46	47	48	49	50
51	52	53	54	55	56	57	58	59	60
61	62	63	64	65	66	67	68	69	70
71	72	73	74	75	76	77	78	79	80
81	82	83	84	85	86	87	88	89	90
91	92	93	94	95	96	97	98	99	100

1	2	3	4	5	6	7	8	9	10
11	12	13	14	15	16	17	18	19	20
21	22	23	24	25	26	27	28	29	30
31	32	33	34	35	36	37	38	39	40
41	42	43	44	45	46	47	48	49	50
51	52	53	54	55	56	57	58	59	60
61	62	63	64	65	66	67	68	69	70
71	72	73	74	75	76	77	78	79	80
81	82	83	84	85	86	87	88	89	90
91	92	93	94	95	96	97	98	99	100

1	2	3	4	5	6	7	8	9	10
11	12	13	14	15	16	17	18	19	20
21	22	23	24	25	26	27	28	29	30
31	32	33	34	35	36	37	38	39	40
41	42	43	44	45	46	47	48	49	50
51	52	53	54	55	56	57	58	59	60
61	62	63	64	65	66	67	68	69	70
71	72	73	74	75	76	77	78	79	80
81	82	83	84	85	86	87	88	89	90
91	92	93	94	95	96	97	98	99	100



Hundrað talna tafla – neikvæðar tölur

-1	-2	-3	-4	-5	-6	-7	-8	-9	-10
-11	-12	-13	-14	-15	-16	-17	-18	-19	-20
-21	-22	-23	-24	-25	-26	-27	-28	-29	-30
-31	-32	-33	-34	-35	-36	-37	-38	-39	-40
-41	-42	-43	-44	-45	-46	-47	-48	-49	-50
-51	-52	-53	-54	-55	-56	-57	-58	-59	-60
-61	-62	-63	-64	-65	-66	-67	-68	-69	-70
-71	-72	-73	-74	-75	-76	-77	-78	-79	-80
-81	-82	-83	-84	-85	-86	-87	-88	-89	-90
-91	-92	-93	-94	-95	-96	-97	-98	-99	-100



Brotarenningar 1

1																																																																																																											
1/2									2/2																																																																																																		
1/3						2/3						3/3																																																																																															
1/4				2/4				3/4				4/4																																																																																															
1/5					2/5					3/5					4/5					5/5																																																																																							
1/6						2/6						3/6						4/6						5/6						6/6																																																																													
1/7							2/7							3/7							4/7							5/7							6/7							7/7																																																																	
1/8								2/8								3/8								4/8								5/8								6/8								7/8								8/8																																																			
1/9						2/9						3/9						4/9						5/9						6/9						7/9						8/9						9/9																																																											
1/10					2/10					3/10					4/10					5/10					6/10					7/10					8/10					9/10					10/10																																																														
1/12				2/12				3/12				4/12				5/12				6/12				7/12				8/12				9/12				10/12				11/12				12/12																																																															
1/15					2/15					3/15					4/15					5/15					6/15					7/15					8/15					9/15					10/15					11/15					12/15					13/15					14/15					15/15																																					
1/16						2/16						3/16						4/16						5/16						6/16						7/16						8/16						9/16						10/16						11/16						12/16						13/16						14/16						15/16						16/16																	
1/18						2/18						3/18						4/18						5/18						6/18						7/18						8/18						9/18						10/18						11/18						12/18						13/18						14/18						15/18						16/18						17/18						18/18					



$\frac{1}{2}$		$\frac{2}{2}$	
$\frac{1}{4}$	$\frac{2}{4}$	$\frac{3}{4}$	$\frac{4}{4}$
$\frac{1}{6}$	$\frac{2}{6}$	$\frac{4}{6}$	$\frac{5}{6}$
$\frac{1}{8}$	$\frac{2}{8}$	$\frac{3}{8}$	$\frac{4}{8}$
$\frac{1}{10}$	$\frac{2}{10}$	$\frac{3}{10}$	$\frac{4}{10}$
$\frac{1}{12}$	$\frac{2}{12}$	$\frac{3}{12}$	$\frac{4}{12}$
$\frac{1}{16}$	$\frac{2}{16}$	$\frac{3}{16}$	$\frac{4}{16}$
$\frac{1}{18}$	$\frac{2}{18}$	$\frac{3}{18}$	$\frac{4}{18}$
$\frac{5}{8}$	$\frac{6}{8}$	$\frac{7}{8}$	$\frac{8}{8}$
$\frac{5}{10}$	$\frac{6}{10}$	$\frac{7}{10}$	$\frac{8}{10}$
$\frac{5}{12}$	$\frac{6}{12}$	$\frac{7}{12}$	$\frac{8}{12}$
$\frac{5}{16}$	$\frac{6}{16}$	$\frac{7}{16}$	$\frac{8}{16}$
$\frac{5}{18}$	$\frac{6}{18}$	$\frac{7}{18}$	$\frac{8}{18}$
$\frac{9}{12}$	$\frac{10}{12}$	$\frac{11}{12}$	$\frac{12}{12}$
$\frac{9}{16}$	$\frac{10}{16}$	$\frac{11}{16}$	$\frac{12}{16}$
$\frac{9}{18}$	$\frac{10}{18}$	$\frac{11}{18}$	$\frac{12}{18}$
$\frac{13}{16}$	$\frac{14}{16}$	$\frac{15}{16}$	$\frac{16}{16}$
$\frac{13}{18}$	$\frac{14}{18}$	$\frac{15}{18}$	$\frac{16}{18}$
$\frac{13}{18}$	$\frac{14}{18}$	$\frac{15}{18}$	$\frac{16}{18}$
$\frac{17}{18}$	$\frac{17}{18}$	$\frac{17}{18}$	$\frac{18}{18}$



$\frac{1}{3}$	$\frac{2}{3}$	$\frac{3}{3}$
$\frac{1}{6}$	$\frac{2}{6}$	$\frac{5}{6}$
$\frac{1}{9}$	$\frac{2}{9}$	$\frac{8}{9}$
$\frac{1}{12}$	$\frac{2}{12}$	$\frac{11}{12}$
$\frac{1}{15}$	$\frac{2}{15}$	$\frac{14}{15}$
$\frac{1}{18}$	$\frac{2}{18}$	$\frac{17}{18}$
$\frac{1}{9}$	$\frac{4}{9}$	$\frac{7}{9}$
$\frac{1}{12}$	$\frac{5}{12}$	$\frac{10}{12}$
$\frac{1}{15}$	$\frac{6}{15}$	$\frac{13}{15}$
$\frac{1}{18}$	$\frac{7}{18}$	$\frac{16}{18}$
$\frac{1}{6}$	$\frac{3}{6}$	$\frac{6}{6}$
$\frac{1}{9}$	$\frac{5}{9}$	$\frac{9}{9}$
$\frac{1}{12}$	$\frac{6}{12}$	$\frac{12}{12}$
$\frac{1}{15}$	$\frac{7}{15}$	$\frac{15}{15}$
$\frac{1}{18}$	$\frac{8}{18}$	$\frac{18}{18}$



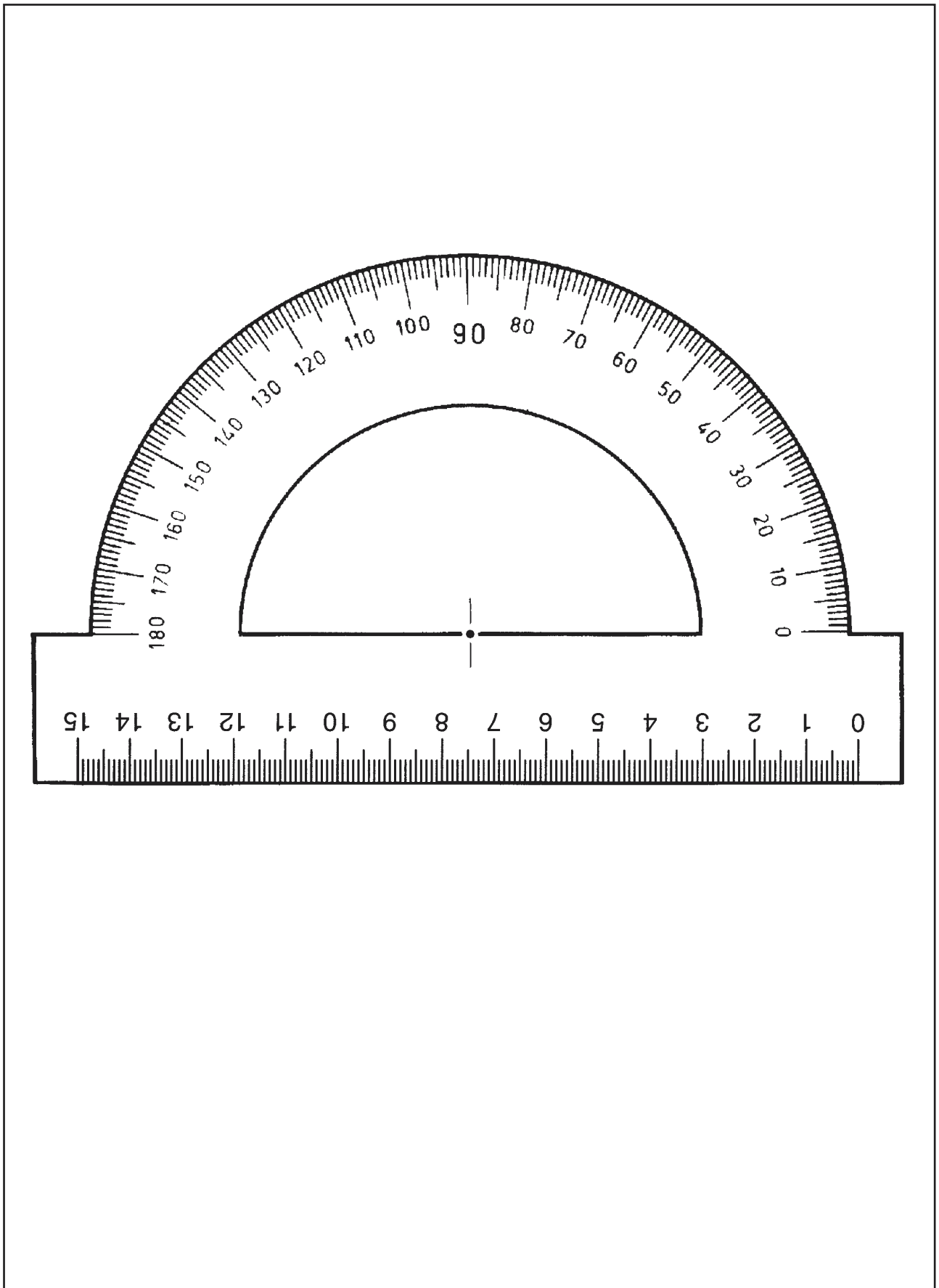

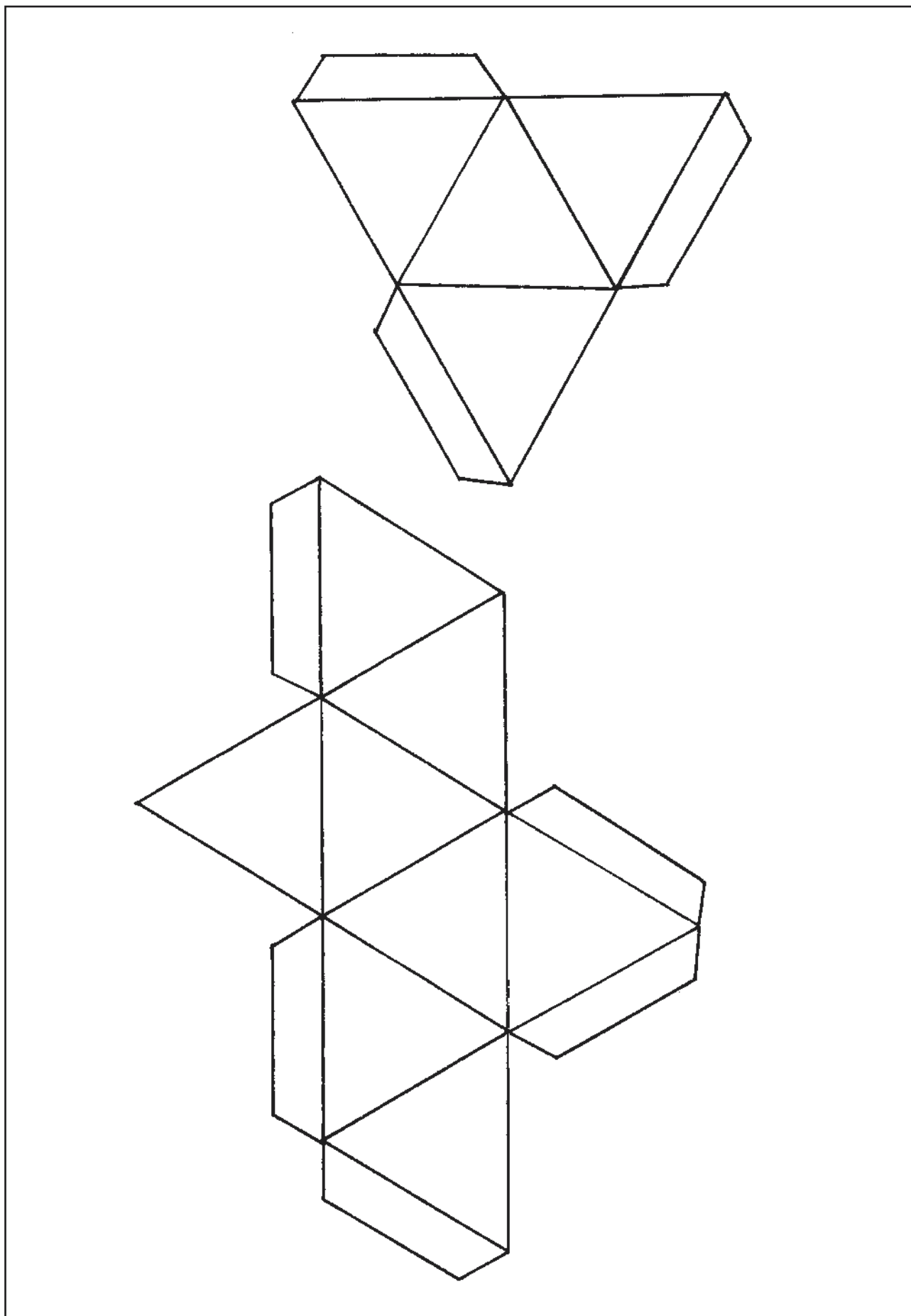

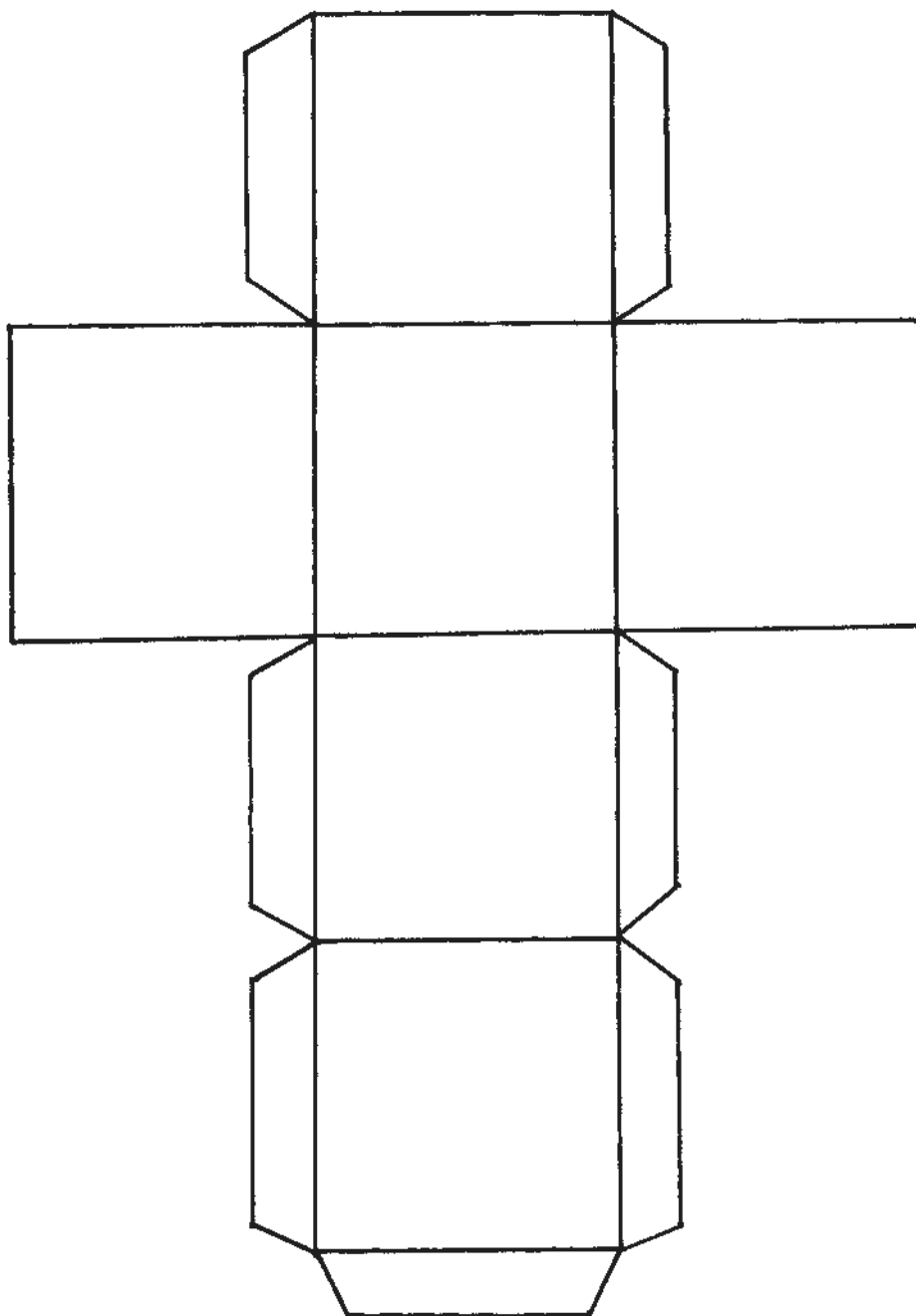

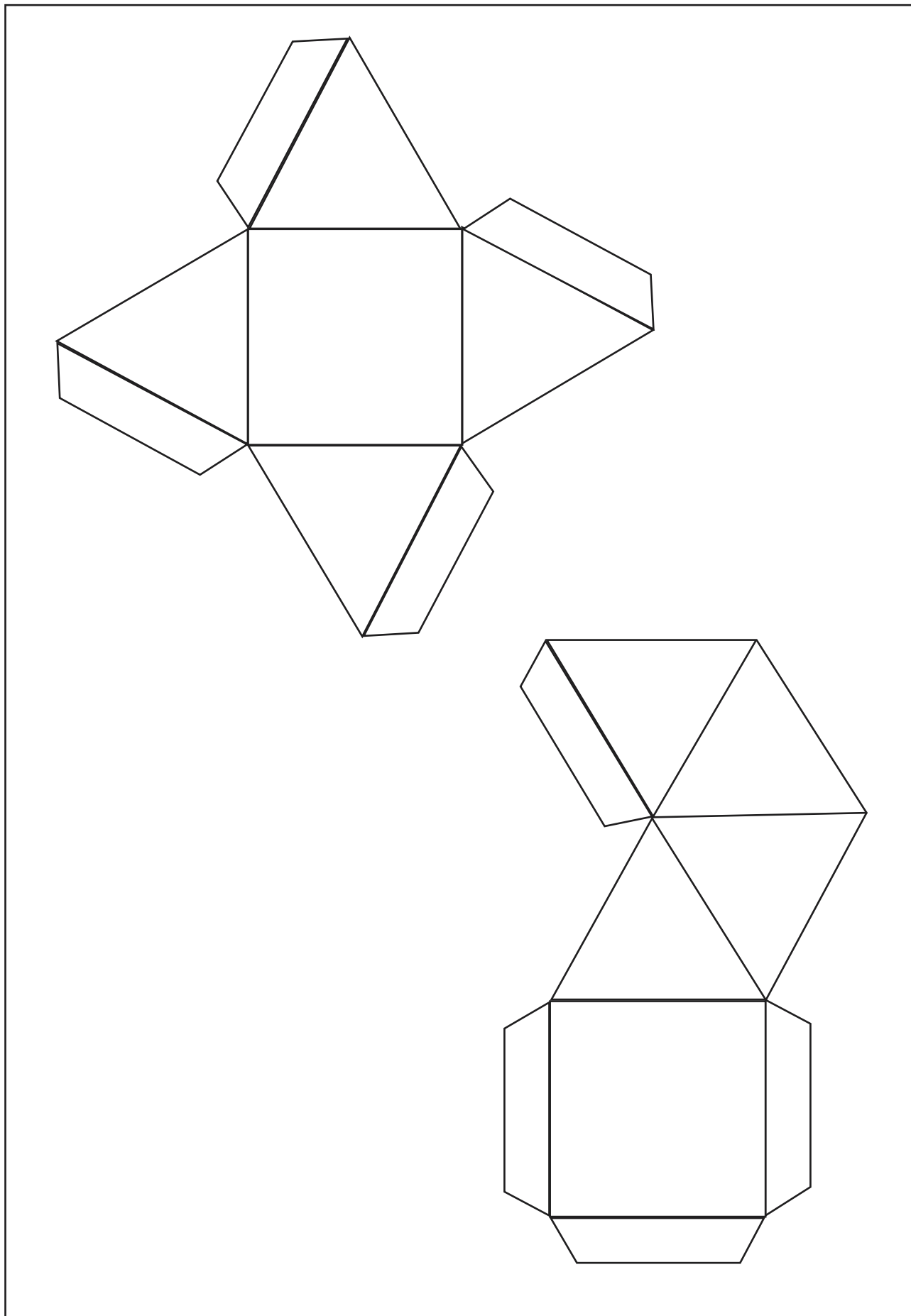

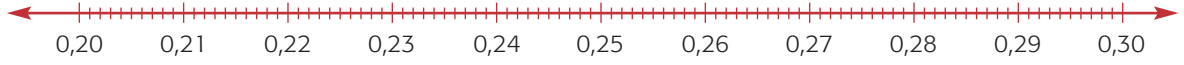
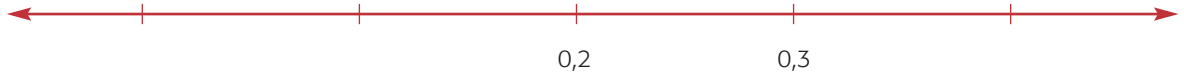

Talnalínur 2

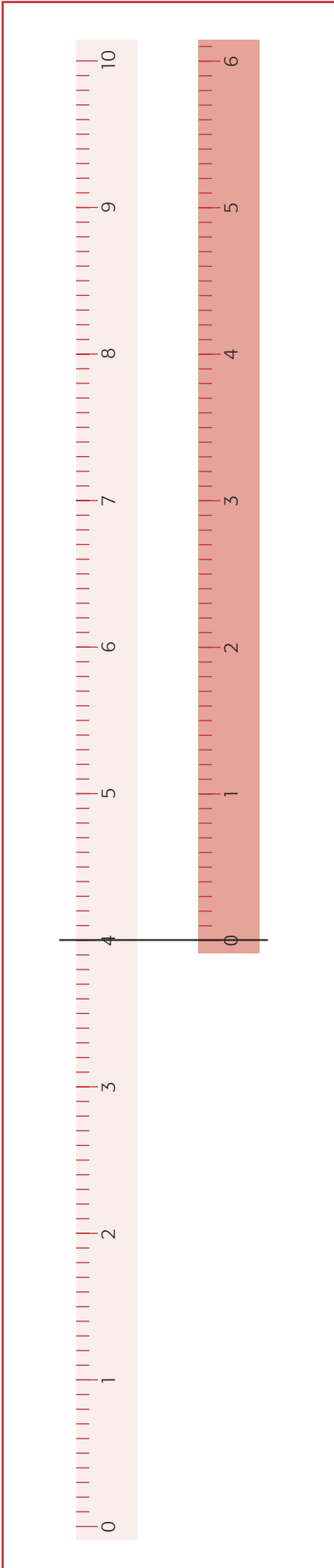

Klipptu renningana út✂

